

right_angled_push_pull_plug_for_bend_relief

size: 0, IP50, keying: 0, number_of_contacts: 3, solder_cup, contact_type: sockets, Signal



Basic information

Part number	W20LOC-P03LJG0-560S
Category	connector
Type of connector	right_angled_plug
Assembly situation	right_angled

Contact insert description

Transmission type	Signal
Number of contacts	3
Contact type	sockets
Contact diameter	0.9 mm
Termination type	solder_cup
Termination diameter	0.85 mm
Wire cross section AWG	AWG 22

Technical information

Max. current single contact	7.5 A	IEC 60512-5-2:2002 (DIN EN 60512-5-2:2003)
Max. current insert	7.5	VDE 0298-4:2003
Test voltage	1.2 kV AC	SAE AS 13441:1998 method 3001.1
Max. creepage distance (contact to contact)	0.8 mm (Contact to housing)	
Max. creepage distance (contact to housing)	1.0 mm (Contact to housing)	
Max. clearance distance (contact to contact)	0.8 mm (Contact to contact)	
Max. clearance distance (contact to housing)	1.0 mm (Contact to housing)	

Cable description

Cable outlet	cable_bend_relief
Min. cable diameter	5
Max. cable diameter	5.6

Mechanical and environmental data

Locking principle	push_pull
Mating cycles	5000
IP class	IP50
Max. operating temperature	120 °C
Min. operating temperature	-40 °C

Material and surface treatments

Material	cu_alloy_with_matt_chrome_finish
Insulator material	peek
Contact material	cu_alloy_with_gold_finish

DIMENSIONS:

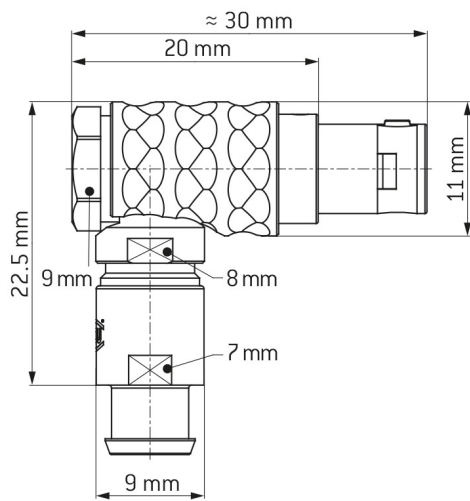

CODING: 0°



POSITIONS: 3 Positions

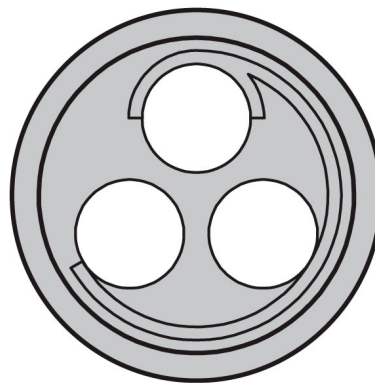

Further technical information and downloads

[3D-File \[STP File\]](#)

[Assembly Instruction](#)

[Technical specifications](#)