

General information

Part number	S22F1C-P05MPH0-300S
Termination	solder
Size	2
Locking principle	push
Coding	1_halfshell
Cable Diameter	cable_mini_30
Cable outlet	bend_relief

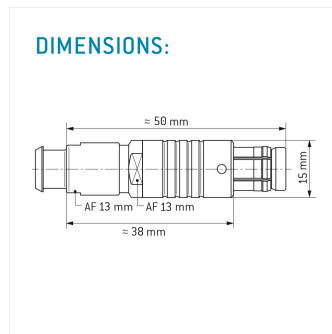

Illustrations may differ from original product.
Dimensions, unless otherwise specified, in mm.

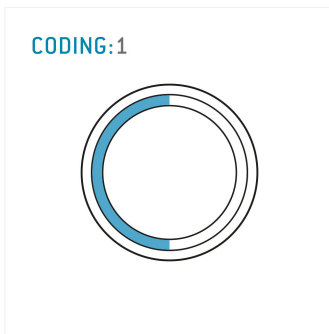

Contact insert description

Number of contacts	5
Contact type	pins
Contact diameter	13mm
Insulator material	peek
Wire cross section	20_awg
Termination	solder
Termination diameter	11mm

reverse_gender_on_request

Technical information

Max. creepage and air clearance distance	12_mm	11_mm
Nominal current single contact	12_a	iec_60512_5_2
Nominal current insert	9 A	vde_0298_4
Test voltage	15_kv_ac	sae_13441

safety_text

Mechanical and environmental data

Degree of protection*	ip50
-----------------------	------

Operating temperature	40_120_c
-----------------------	----------

Mating cycles	5000
---------------	------

mated_unmated

Material and surface treatments

Housing	m_chrome
---------	----------

Contact	cu_alloy_gold
---------	---------------

safety_text_2

ul_text

illustrative_text