

## General information

Part number	S21KCC-P07MFG0-400S
Termination	solder
Size	1
Locking principle	push
Coding	c_key
Cable Diameter	cable_mini_40
Cable outlet	bend_relief

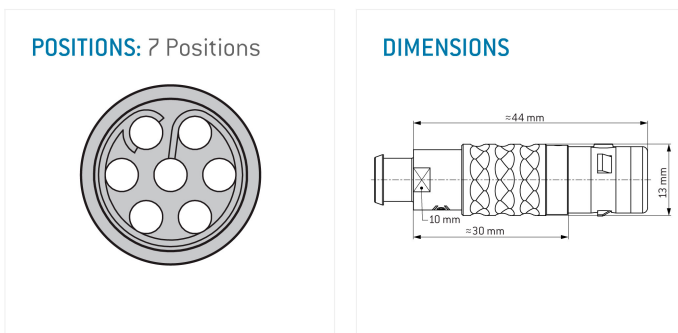

Illustrations may differ from original product.  
Dimensions, unless otherwise specified, in mm.



The pin layout corresponds to the view on the termination area

## Contact insert description

Number of contacts	7
Contact type	pins
Contact diameter	07mm
Insulator material	peek
Wire cross section	22_awg
Termination	solder
Termination diameter	085mm

reverse\_gender\_on\_request

## Technical information

Max. creepage and air clearance distance	07_mm	07_mm
Nominal current single contact	075_a	iec_60512_5_2
Nominal current insert	4,875 A	vde_0298_4
Test voltage	1_kv_ac	sae_13441

safety\_text

## Mechanical and environmental data

Degree of protection*	ip68
Operating temperature	40_120_c
Mating cycles	5000

mated

## Material and surface treatments

Housing	m_chrome
Contact	cu_alloy_gold

safety\_text\_2  
ul\_text  
illustrative\_text