

straight_push_pull_plug

size: 1, IP50, keying: c, number_of_contacts: 2, solder_cup, contact_type: pins, Signal

**Basic information**

Part number	S11MCC-P02MPHO-6540
Category	connector
Type of connector	plug
Assembly situation	straight
Size	1

Contact insert description

Transmission type	Signal
Number of contacts	2
Contact type	pins
Contact diameter	1.3 mm
Termination type	solder_cup
Termination diameter	1.1 mm
Wire cross section AWG	AWG 20

Technical information

Max. current single contact	12 A	IEC 60512-5-2:2002 (DIN EN 60512-5-2:2003)
Max. current insert	12	VDE 0298-4:2003
Test voltage	1.4 kV AC	EIA-364-20F:2019-02
Max. creepage distance (contact to contact)	1.3 mm (Contact to housing)	
Max. clearance distance (contact to contact)	1.3 mm (Contact to contact)	

Cable description

Cable outlet	back_nut
Min. cable diameter	5.3
Max. cable diameter	6.5

Mechanical and environmental data

Locking principle	push_pull
Keying	c
Mating cycles	2000
IP class	IP50
Max. operating temperature	120 °C
Min. operating temperature	50 °C

Material and surface treatments

Material	cu_alloy_with_matt_chrome_finish
Insulator material	peek
Contact material	cu_alloy_with_gold_finish
Color option (Front or back nut)	yellow

DIMENSIONS



CODING: 60°



POSITIONS: 2 Positions

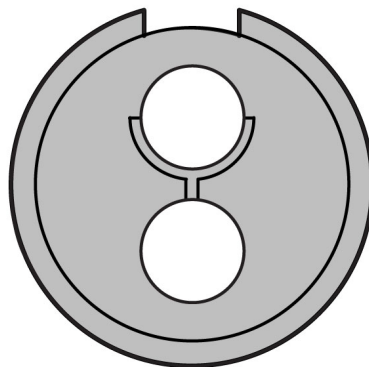

Further technical information and downloads

[3D-File \[STP File\]](#)

[Assembly Instruction](#)