

General information

Part number	K11K0C-P02LPH0-2500
Termination	solder
Size	1
Locking principle	break , push
Coding	0_key
Cable Diameter	cable_mini_25
Cable outlet	standard

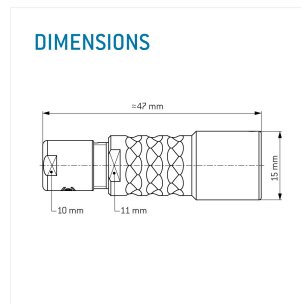

Illustrations may differ from original product. Dimensions, unless otherwise specified, in mm.

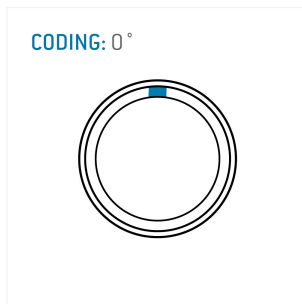

The pin layout corresponds to the view on the termination area

Contact insert description

Number of contacts	2
Contact type	sockets
Contact diameter	13mm
Insulator material	peek
Wire cross section	20_awg
Termination	solder
Termination diameter	11mm

reverse_gender_on_request

Technical information

Max. creepage and air clearance distance	10_mm	07_mm
Nominal current single contact	12_a	iec_60512_5_2
Nominal current insert	12 A	vde_0298_4
Test voltage	165_kv_ac	sae_13441

safety_text

Mechanical and environmental data

Degree of protection*	ip68
-----------------------	------

Operating temperature	40_120_c
-----------------------	----------

Mating cycles	5000
---------------	------

mated

Material and surface treatments

Housing	m_chrome
---------	----------

Contact	cu_alloy_gold
---------	---------------

safety_text_2

ul_text

illustrative_text