

General information

Part number	K10KAC-P02LJG0-4500
Termination	solder
Size	0
Locking principle	break , push
Coding	a_key
Cable Diameter	cable_minj_45
Cable outlet	standard

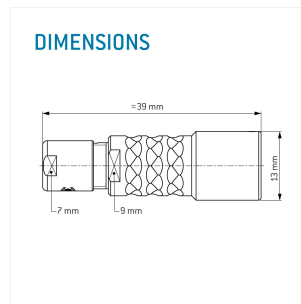

Illustrations may differ from original product. Dimensions, unless otherwise specified, in mm.

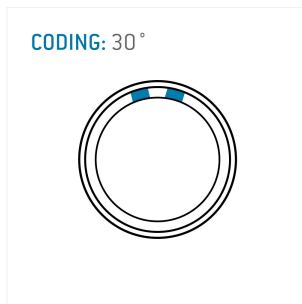

The pin layout corresponds to the view on the termination area

Contact insert description

Number of contacts	2
Contact type	sockets
Contact diameter	09mm
Insulator material	peek
Wire cross section	22_awg
Termination	solder
Termination diameter	085mm

reverse_gender_on_request

Technical information

Max. creepage and air clearance distance	10_mm	09_mm
Nominal current single contact	075_a	iec_60512_5_2
Nominal current insert	7,5 A	vde_0298_4
Test voltage	15_kv_ac	sae_13441

safety_text

Mechanical and environmental data

Degree of protection*	ip68
Operating temperature	40_120_c
Mating cycles	5000

mated

Material and surface treatments

Housing	m_chrome
Contact	cu_alloy_gold

safety_text_2
ul_text
illustrative_text