

receptacle_with_break_away_and_push_pull_locking_for_front_panel_mounting

size: 00, IP50, keying: a, number_of_contacts: 4, solder_cup, contact_type: sockets, Signal



Basic information

Part number	G1CLAC-P04LCC0-0000
Category	connector
Type of connector	receptacle
Assembly situation	front_panel_mounting
Size	00

Contact insert description

Transmission type	Signal
Number of contacts	4
Contact type	sockets
Contact diameter	0.5 mm
Termination type	solder_cup
Termination diameter	0.45 mm
Wire cross section AWG	AWG 28

Technical information

Max. current single contact	4 A	IEC 60512-5-2:2002 (DIN EN 60512-5-2:2003)
Max. current insert	4	VDE 0298-4:2003
Test voltage	0.9 kV AC	SAE AS 13441:1998 method 3001.1
Max. creepage distance (contact to contact)	0.4 mm (Contact to housing)	
Max. creepage distance (contact to housing)	0.6 mm (Contact to housing)	
Max. clearance distance (contact to contact)	0.4 mm (Contact to contact)	
Max. clearance distance (contact to housing)	0.6 mm (Contact to housing)	

Mechanical and environmental data

Locking principle	break_away , push_pull
Keying	coding_30°
Mating cycles	5.000
IP class	IP50
Max. operating temperature	120 °C
Min. operating temperature	-40 °C
Tightening torque	0.8 Nm
Weight	2.44 g

Material and surface treatments

Material	cu_alloy_with_matt_chrome_finish
Contact material	gold

DIMENSIONS

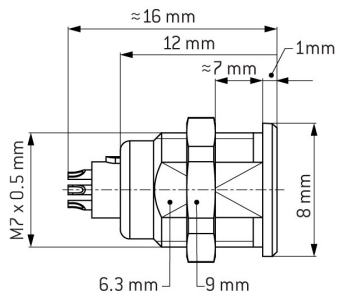

CODING: 30°



POSITIONS: 4 Positions

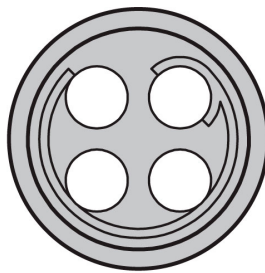

PANEL CUT OUT:

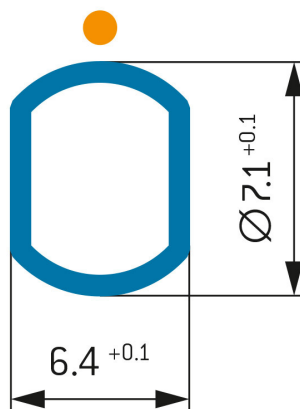

Further technical information and downloads

[3D-File \(STP File\)](#)

[Technical specifications](#)